

**PRODUCT SPECIFICATIONS**

Elkay Stainless Steel 23" x 18-1/2" x 12", Wall Hung Service Sink Kit.  
Sink is manufactured from 14 gauge 304 Stainless Steel with a Buffed Satin finish, .

<b>Material:</b>	304 Stainless Steel
<b>Finish:</b>	Buffed Satin
<b>Gauge:</b>	14
<b>Number of Bowls:</b>	1
<b>Sink Dimensions:</b>	23" x 18-1/2" x 39-3/4"
<b>Bowl 1 Dimensions:</b>	20" x 15" x 12"
<b>Drain Size:</b>	3-1/2" (89mm)



**Included with Product:** ESSW2319 sink,  
one LKB940C faucet,  
one LK173 cast iron P-trap

▼ **Ships in multiple boxes.**

**AMERICAN PRIDE. A LIFETIME TRADITION.**

Like your family, the Elkay family has values and traditions that endure. For almost a century, Elkay has been a family-owned and operated company, providing thousands of jobs that support our families and communities.



**Product Compliance:** ASME A112.19.3/CSA B45.4  
BUY AMERICAN ACT  
Faucet: ADA & ICC A117.1  
ASME A112.18.1/CSA B125.1  
NSF 61



Faucet complies with ADA & ICC A117.1 accessibility requirements when installed according to the requirements outlined in these standards.

[Clean and Care Manual \(PDF\)](#)  
[Installation Instructions \(PDF\)](#)  
[Limited Warranty \(PDF\)](#)

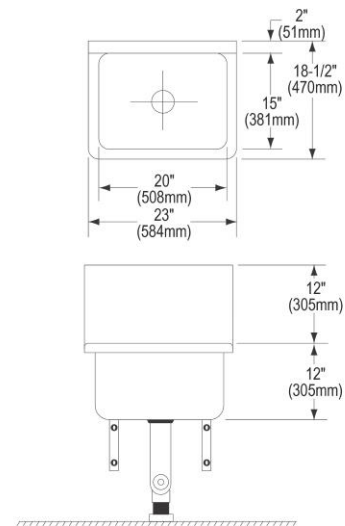

PART: \_\_\_\_\_ QTY: \_\_\_\_\_

PROJECT: \_\_\_\_\_

CONTACT: \_\_\_\_\_

DATE: \_\_\_\_\_

NOTES: \_\_\_\_\_

APPROVAL: \_\_\_\_\_

*In keeping with our policy of continuing product improvement, Elkay reserves the right to change product specifications without notice. Please visit [elkay.com](http://elkay.com) for the most current version of Elkay product specification sheets. This specification describes an Elkay product with design, quality, and functional benefits to the user. When making a comparison of other producers' offerings, be certain these features are not overlooked.*

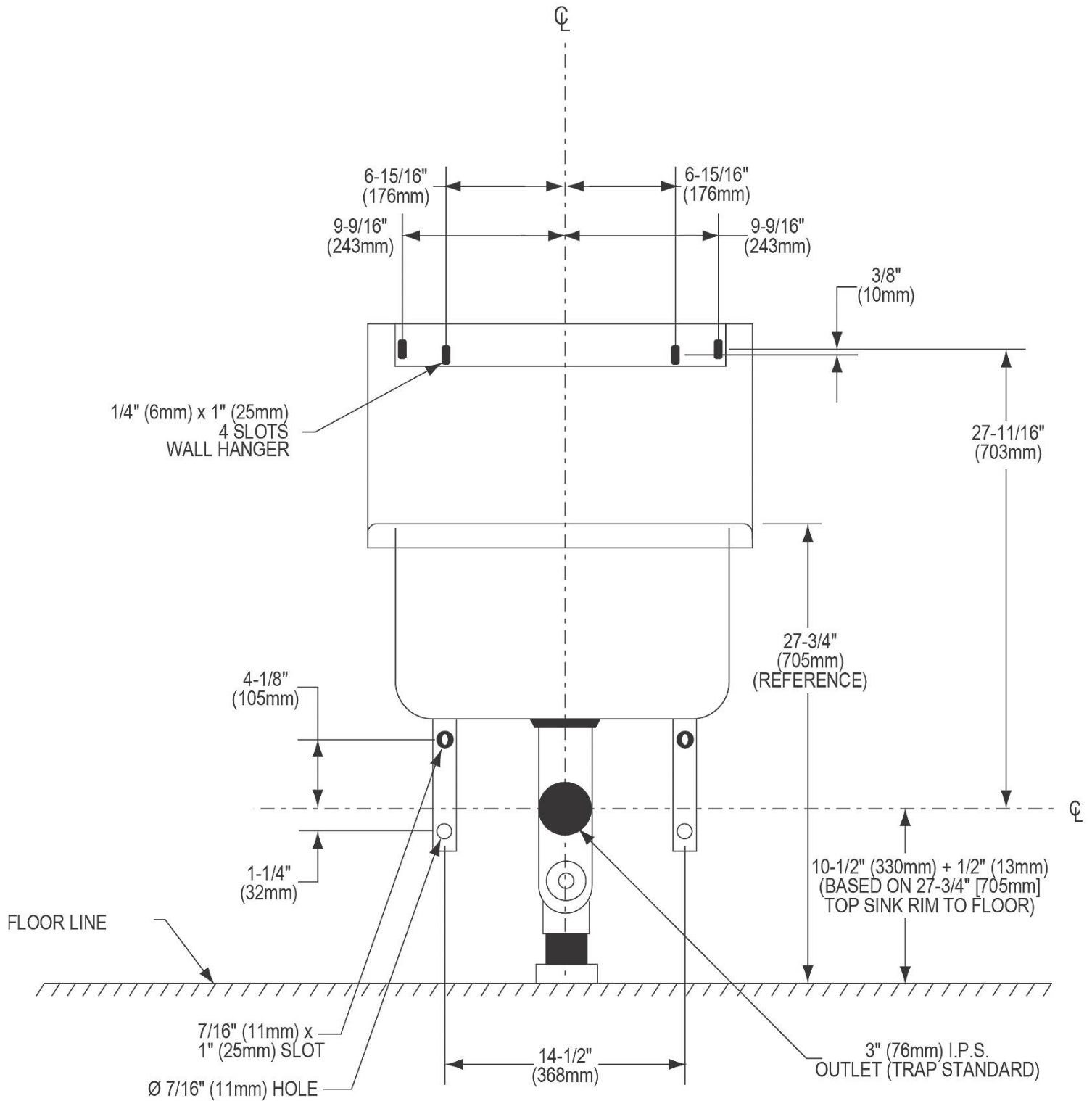

In keeping with our policy of continuing product improvement, Elkay reserves the right to change product specifications without notice. Please visit [elkay.com](http://elkay.com) for the most current version of Elkay product specification sheets. This specification describes an Elkay product with design, quality, and functional benefits to the user. When making a comparison of other producers' offerings, be certain these features are not overlooked.