

PRODUCT SPECIFICATIONS

Elkay Stainless Steel 60" x 20" x 8", Wall Hung Multiple Station Hand Wash Sink. Sink is manufactured from 14 gauge 304 Stainless Steel with a Buffed Satin finish.

Material:	304 Stainless Steel
Finish:	Buffed Satin
Gauge:	14
Number of Bowls:	1
Sink Dimensions:	60" x 20" x 25-3/4"
Bowl 1 Dimensions:	57" x 16-1/2" x 8"
Backsplash Height:	10
Drain Size:	3-1/2" (89mm)

Custom Options	
Drain Location	
<input type="checkbox"/> Right Rear	<input type="checkbox"/> Left Rear
Alternate Punching	
<input type="checkbox"/> Faucet Model:	<input type="checkbox"/> Punch Required:

*Options available if applicable



AMERICAN PRIDE. A LIFETIME TRADITION.
Like your family, the Elkay family has values and traditions that endure. For almost a century, Elkay has been a family-owned and operated company, providing thousands of jobs that support our families and communities.



Product Compliance: ASME A112.19.3/CSA B45.4
BUY AMERICAN ACT

 Sinks are listed by IAPMO[®] as meeting the applicable requirements of the Uniform Plumbing Code[®], International Plumbing Code[®], and National Plumbing Code of Canada.

[Clean and Care Manual \(PDF\)](#)
[Limited Warranty \(PDF\)](#)

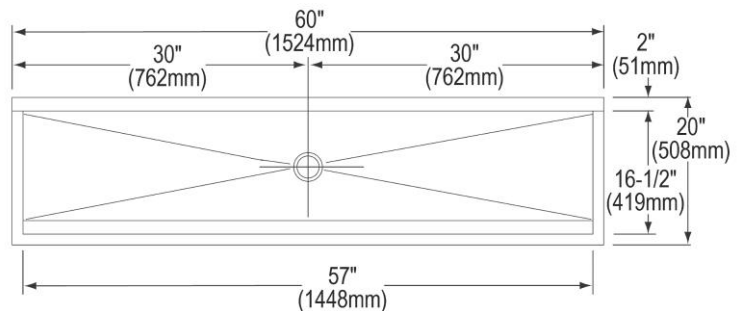
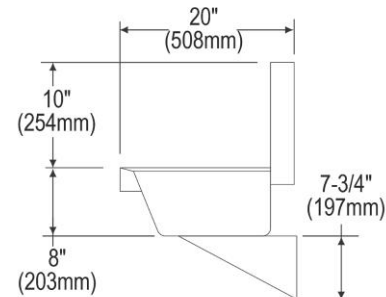

PART: _____ QTY: _____

PROJECT: _____

CONTACT: _____

DATE: _____

NOTES: _____

APPROVAL: _____

In keeping with our policy of continuing product improvement, Elkay reserves the right to change product specifications without notice. Please visit elkay.com for the most current version of Elkay product specification sheets. This specification describes an Elkay product with design, quality, and functional benefits to the user. When making a comparison of other producers' offerings, be certain these features are not overlooked.

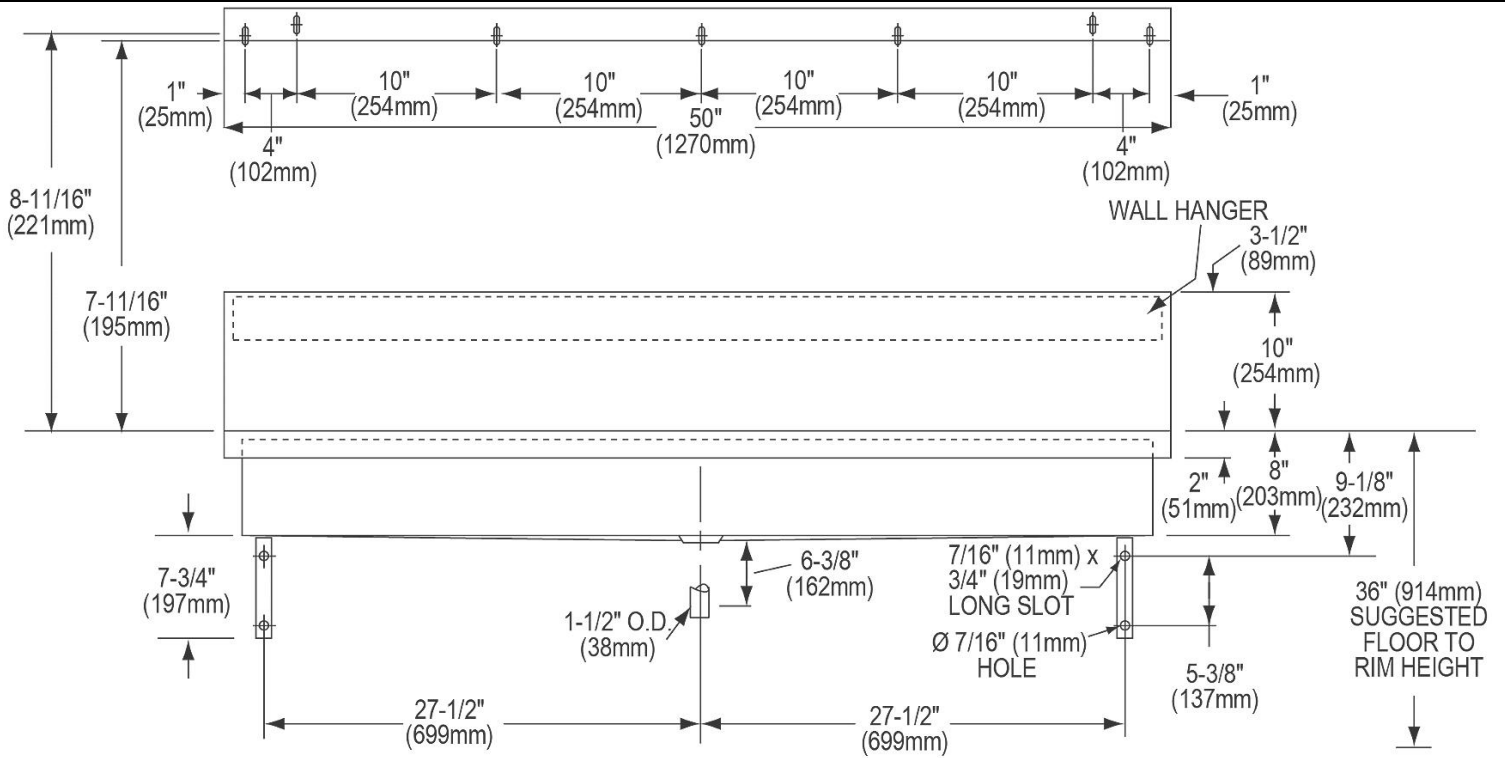

In keeping with our policy of continuing product improvement, Elkay reserves the right to change product specifications without notice. Please visit elkay.com for the most current version of Elkay product specification sheets. This specification describes an Elkay product with design, quality, and functional benefits to the user. When making a comparison of other producers' offerings, be certain these features are not overlooked.