



ASSEMBLING & INSTALLATION INSTRUCTIONS

The drawing shown may not exactly match the product enclosed.
However, the installation instructions do apply to this product.

49994 49344 49348

- ◆ **WARNING! SHUT POWER OFF AT FUSE OR CIRCUIT BREAKER.**
- ◆ **ATTENTION! COUPER LE COURANT AU FUSIBLE OU UN DISJONCTEUR.**

ASSEMBLING THE FIXTURE (Fig.1)

1. Shut off the power at the circuit breaker box. Remove old fixture and all hardware from Junction Box.
2. Carefully unpack your new fixture and lay out all the parts on a clear area. Take care not to lose any small parts necessary for installation.
3. Determine the desired hanging height. Slide the electrical wires through the tubes(D)/(C)/(B) and canopy(A).
4. Raise the tube(D)/(C)/(B) and canopy(A) to the pipe thread in order, then by turning it clockwise until tight.
5. Thread the two mounting screws into the pre-drilled holes in the Mounting plate spaced the same distance apart as the holes in the canopy (A). Attach the Mounting plate to the Junction Box with the two Junction Box screws as shown. **The side of the Mounting plate marked "GND" must face to out.**
6. While holding the fixture lamp towards the ceiling, connect the electrical wires as Shown in Fig.2, making sure that all wire nuts are secured. You may have to wrap the connections with electrical tape. If your outlet has a ground wire (green or bare copper), connect the fixture ground wire to it. Otherwise connect fixture's ground wire directly to the Mounting plate with the green screw provided. After wires are connected, tuck them carefully inside the Junction Box.
7. Raise the canopy (A) on to the Junction box, aligning screws on mounting plate with mounting holes in canopy and lock it securely with the column nuts.
8. **WARNING: RETURN THE ARMS TO THE SUITABLE POSITION, BUT DOES NOT A CONTINUOUS ROTATION OF AN ENTIRE ARM !**
9. Install the light bulbs(Not included) in accordance with the fixture specifications. **NOTE: DO NOT EXCEED THE SPECIFIED WATTAGE!**

Your installation is now complete. Return power to the junction box and test the fixture.

FIG.1

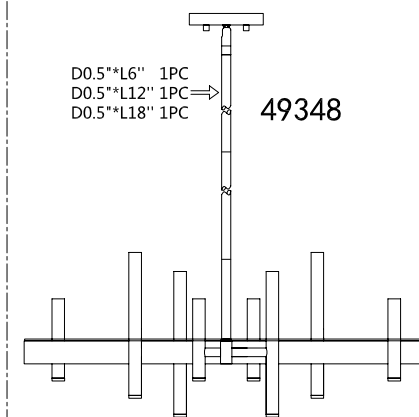
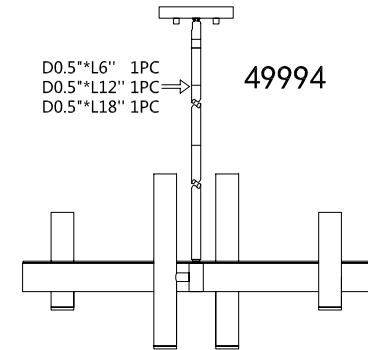
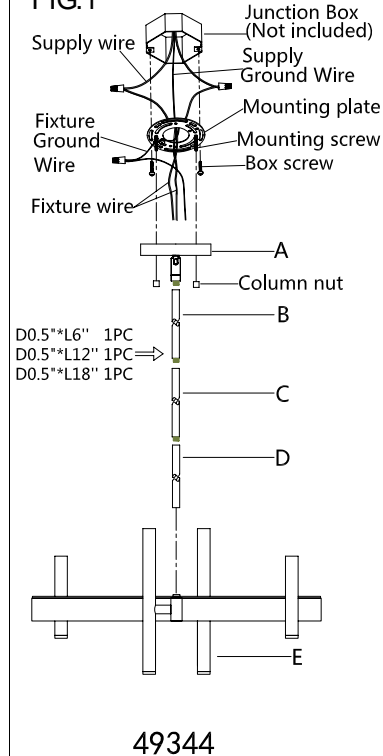
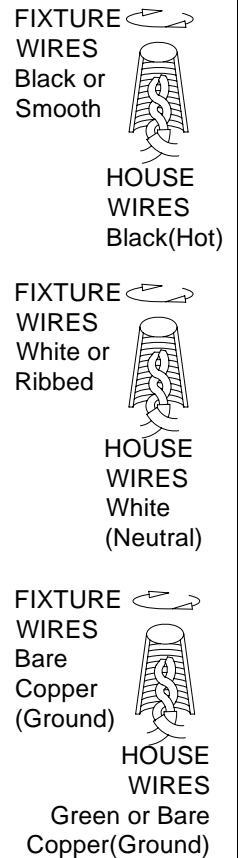

FIG.2



Thank you for purchasing a **LIVEX** product.
 Need assistance with parts or assembly? Please call customer service at: **800-761-8056**
 Or visit us online at: WWW.LIVEXLIGHTING.COM