

Tools Required

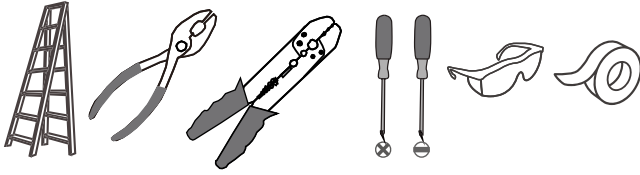

Light Source

22W
LED

Warnings and Cautions

Turn off the electricity at the circuit breaker before installation. Consult a licensed electrician if in doubt about installation.

Package Contents

Preparation: Identify and inspect all parts before beginning the installation.

Missing or damaged parts? Contact your original place of purchase.

PARTS BAG

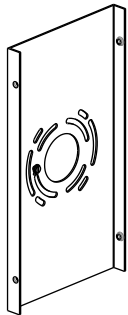

A Inner Backplate
x 1

B Lock Screw
x 4

C Outlet Box Screw
x 2

D Wire Connector
x 3

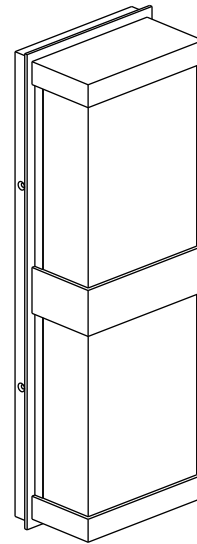

E Fixture Body
x 1

Table of Contents

Inner Backplate

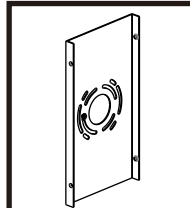

STEP 1

Wiring

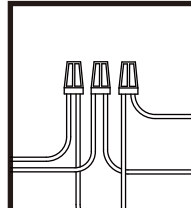

STEP 2

Fixture Body

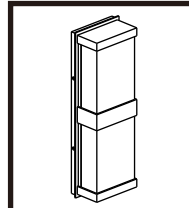

STEP 3

Caulk

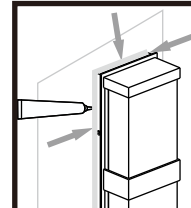

STEP 4

STEP 1

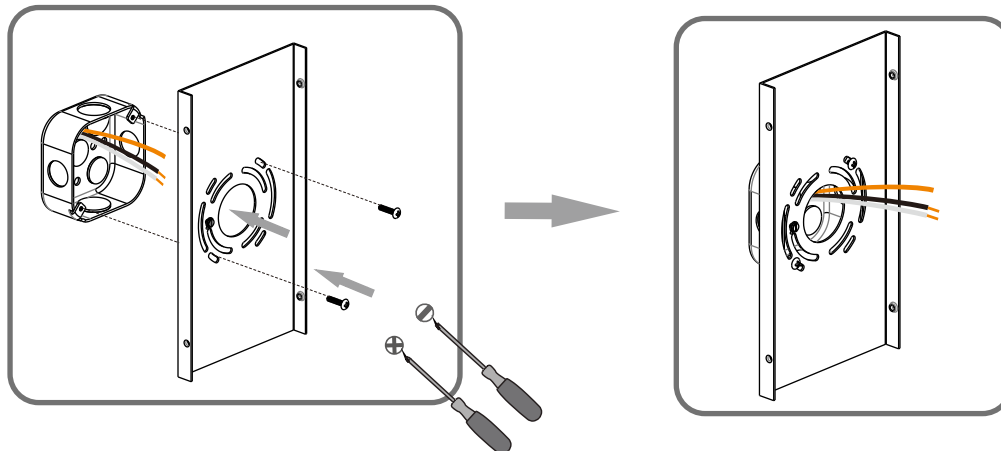

STEP 2

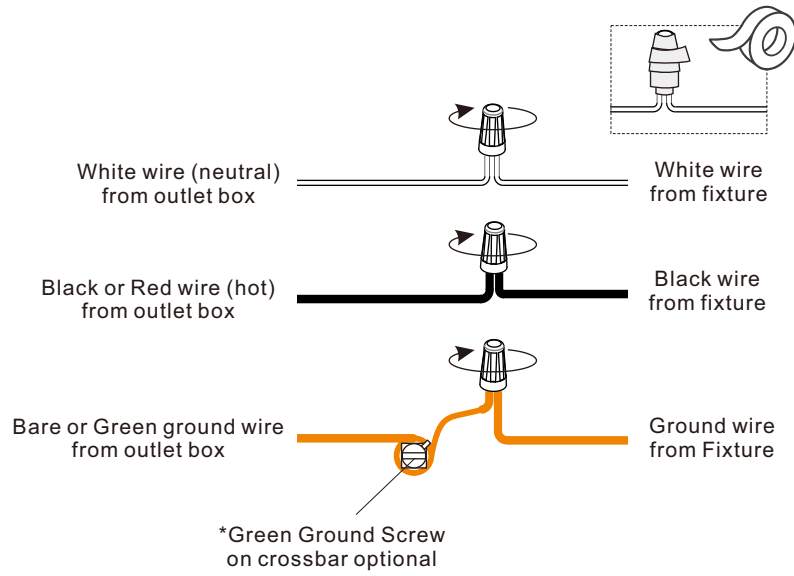

STEP 3

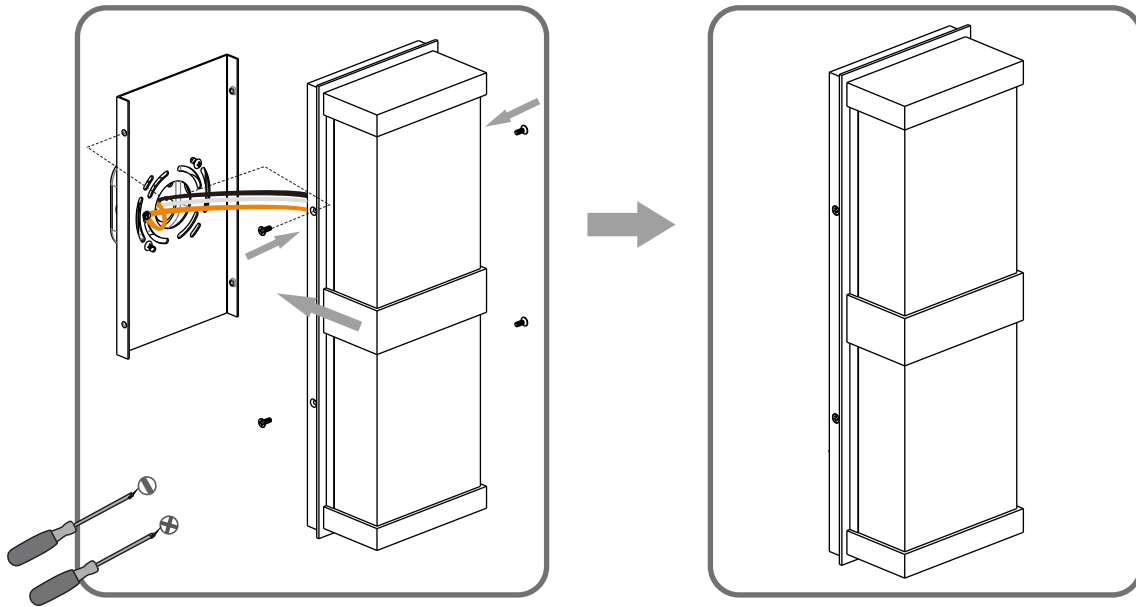

STEP 4

