

**Tools Required**

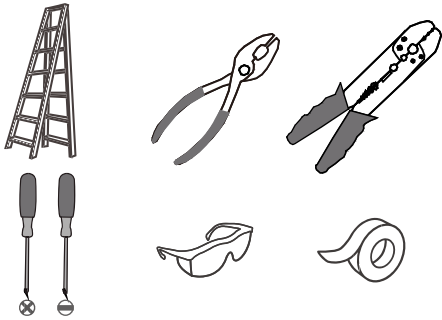

**Light Source**

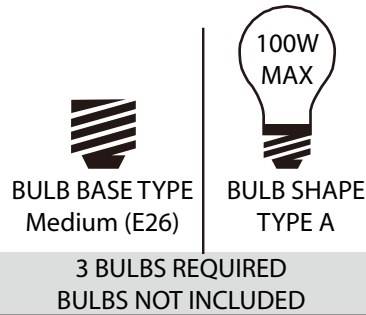

**Warnings and Cautions**

Turn off the electricity at the circuit breaker before installation. Consult a licensed electrician if in doubt about installation.

Turn off power to the fixture and allow the bulbs to cool before replacing.

**Package Contents**

Preparation: Identify and inspect all parts before beginning the installation.

Missing or damaged parts? Contact your original place of purchase.

**PARTS BAG**

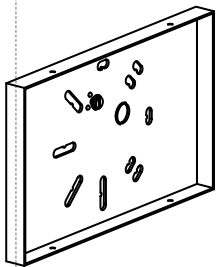

- A** Inner Backplate x 1
- B** Mounting Screw x 4
- C** Outlet Box Screw x 2
- D** Wire Connector x 3

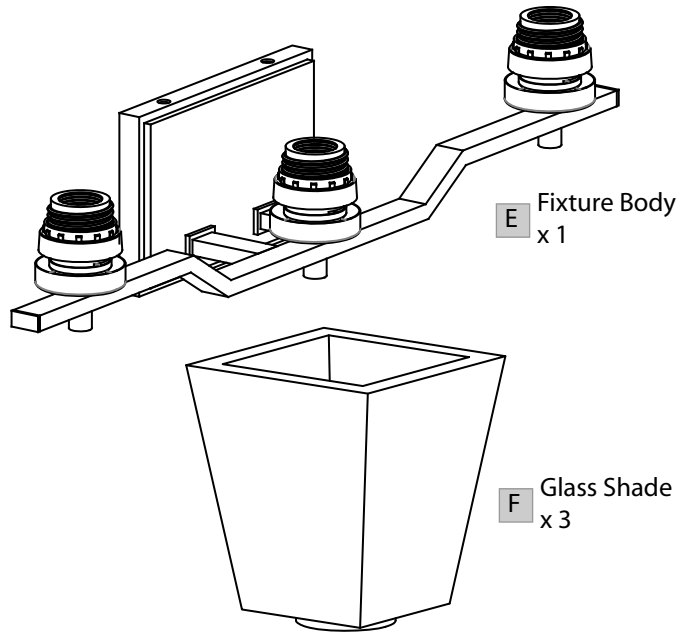

**Table of Contents**

**Inner Backplate**

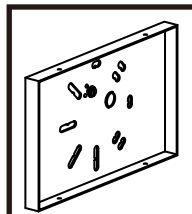

STEP 1

**Wiring**

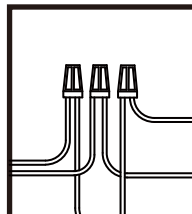

STEP 2

**Fixture Body**

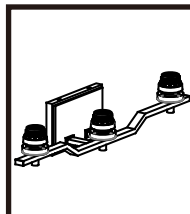

STEP 3

**Glass Shade and Bulb**

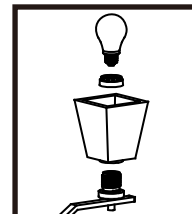

STEP 4

### STEP 1

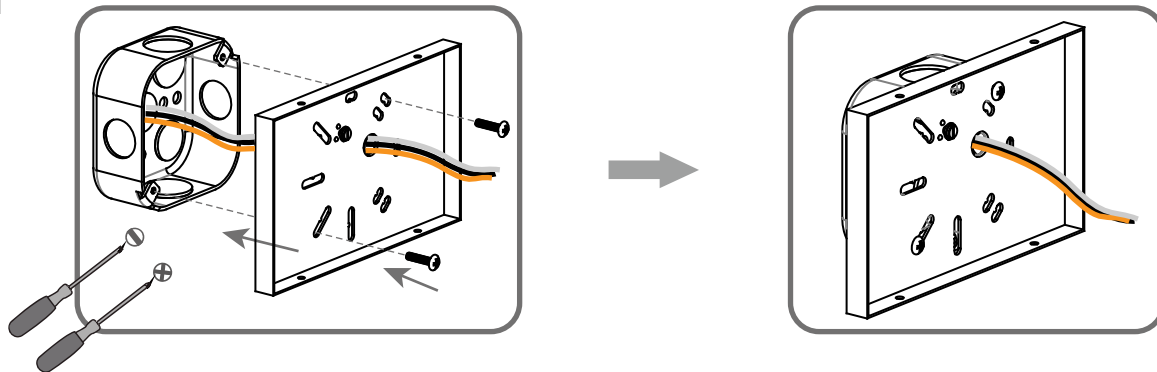

### STEP 2

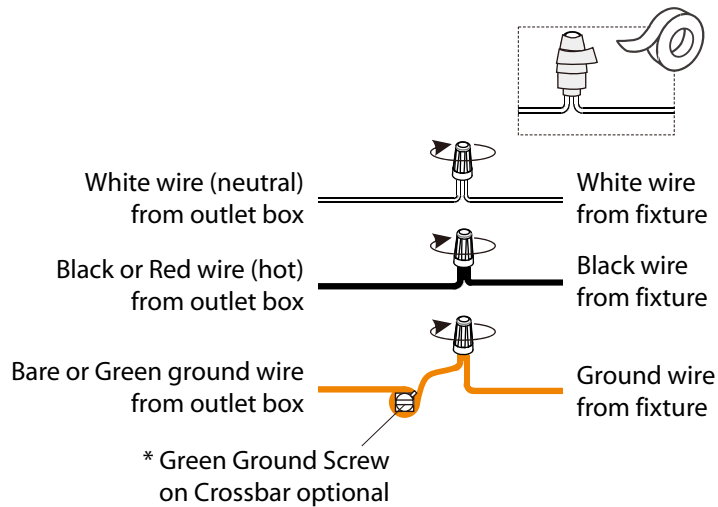

### STEP 3

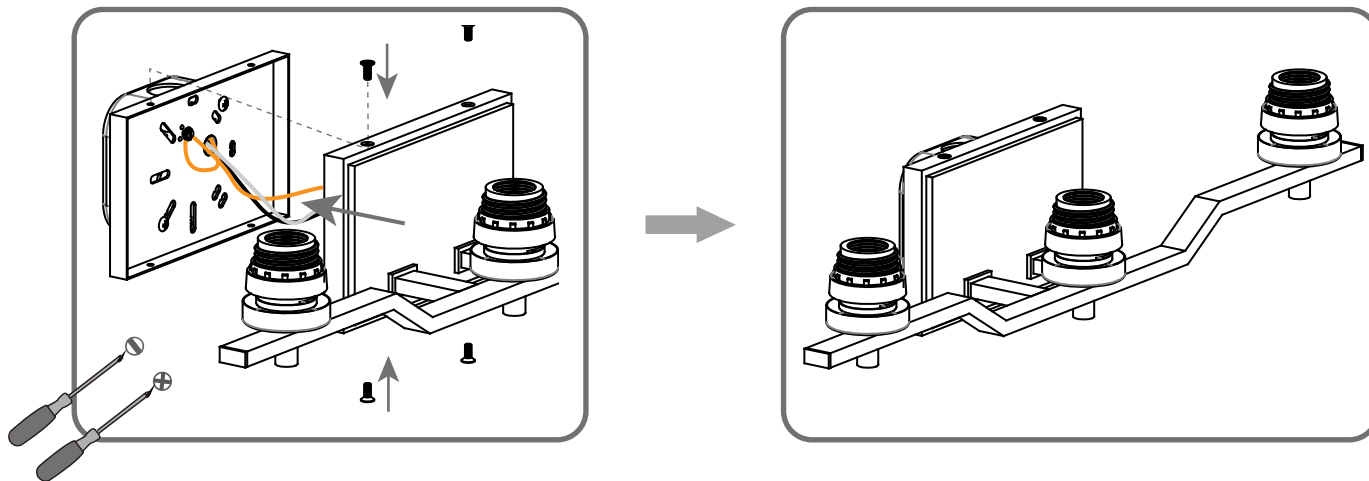

# STEP 4

1

Remove socket collar

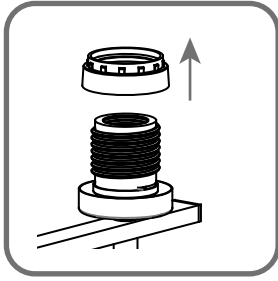

2

Install glass shade and bulb

