

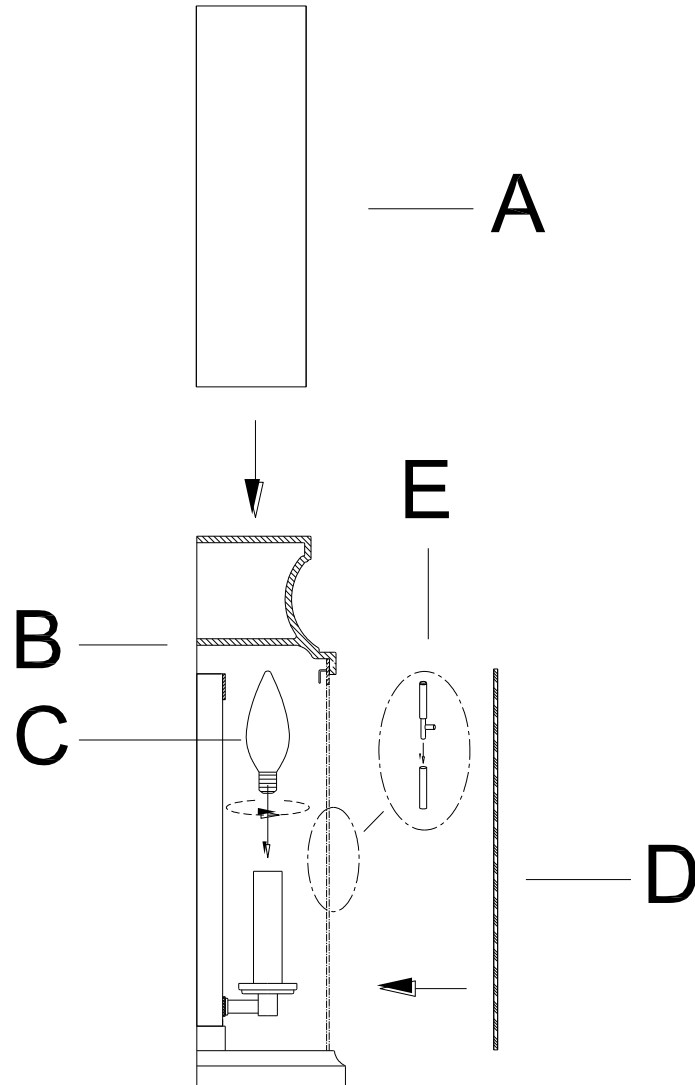

ASSEMBLY INSTRUCTIONS

ITEM NO.: 5-5911-BK



A → B → D → C → E

1. Carefully unpack and identify all parts referring to illustration for parts identification.
2. Turn the power to the installation point **OFF**.
3. Insert glass panels (A) (D) onto the fixture (B), attach with the clips along.
4. Install proper bulbs (C) (not provided) to the socket.
5. Close the front door and attach the pin (E) onto the fixture (B).
6. Retain power to the installation point **ON** and retain this sheet for future reference.